

搖搖晃晃的橋

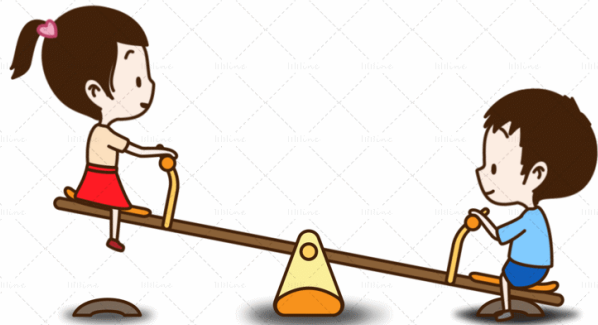

生活中的平衡



一上一下，
一升一降，
重的那邊往下沉，
輕的那邊往上翹。

跷跷板



生活中的平衡



衣架

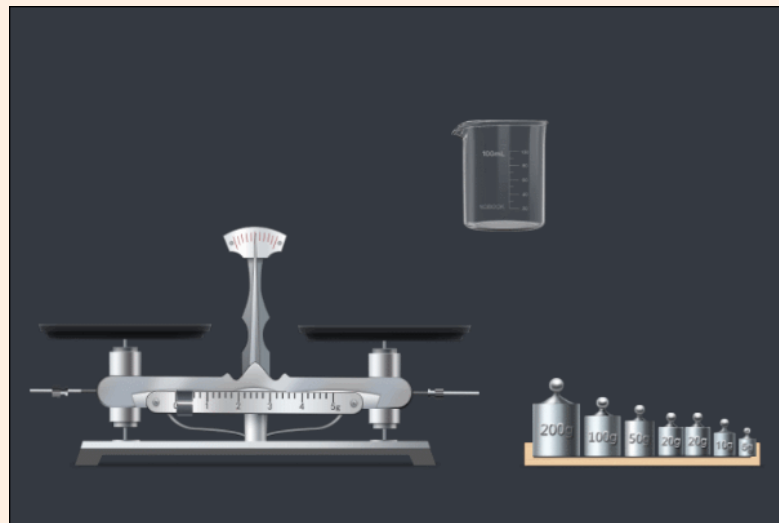

天平

搖搖晃晃的橋

木村裕一/文 藥好史郎/圖 朱自強/譯



下了幾天的大雨終於停了，
被大雨沖壞的橋上，
只剩下了一根原木。





“呼哧、呼哧、呼哧……”

一隻兔子跑到了橋上。

“等我跑過去，把原木往下一推，就可以逃脫了。”

就在這時，狐狸追了上來。

A stylized illustration of a fox and a rabbit on a log. The fox is on the left, and the rabbit is on the right. The log is a thick, dark brown horizontal line. Above the fox, the sound effect '咚——' is written in blue. The fox has large, flowing red and orange leaves or fur. The rabbit is dark grey with white accents. The background is white with some dark grey shapes on the left and a red and orange structure on the right.

咚——

“只要不讓他跑過原木，就能抓住他！”說著，狐狸跳上了原木。

原木劇烈地抖動起來。

“啊！”兔子大喊一聲，緊緊地抱住原木。

An illustration of a fox and a rabbit on a log bridge. The fox is on the left, walking towards the right. The rabbit is on the right, walking towards the left. The bridge is a dark brown log supported by a wooden post. The background is white with some blue and green abstract shapes.

咚——

狐狸得意地笑了。他踹得原木咚咚作響，向前走去。

“哼，我不會讓你輕鬆過橋的！”



原木終於失去了支撐，忽忽悠悠地晃動起來。

可是，狐狸翹著尾巴，逼近了兔子。

“嘿嘿嘿，你逃不掉啦！”

吱吱吱吱吱

這樣一來，橋不斷地傾斜起來。

“站住！別再過來了，我們會和原木一起掉進河裏的！”

兔子喊了起來。

“噓！危、危險！”
狐狸慌忙停下來。



活動一——狐狸和兔子遇險

實驗記錄表



活動1			
狐狸	兔子	橋是平衡的嗎?	
		✓	×

活動一——狐狸和兔子遇險

實驗記錄表

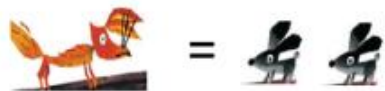

活動1			
狐狸	兔子	橋是平衡的嗎?	
		✓	×

活動一——狐狸和兔子遇險

實驗記錄表

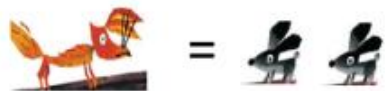





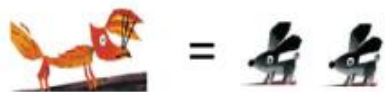

活動1			
狐狸	兔子	橋是平衡的嗎?	
		✓	×

活動一——狐狸和兔子遇險

實驗記錄表



活動1		
狐狸	兔子	橋是平衡的嗎?
		<input checked="" type="checkbox"/> <input type="checkbox"/>

		<p>✓</p>	<p>×</p>
		<p>✓</p>	<p>×</p>
		<p>✓</p>	<p>×</p>

實驗結果 - 狐狸在哪裏能獲得平衡？



實驗結果 - 狐狸在哪裏能獲得平衡？

		✓	✗
---	--	---	---

實驗結論 - 距離是影響平衡的因素之一

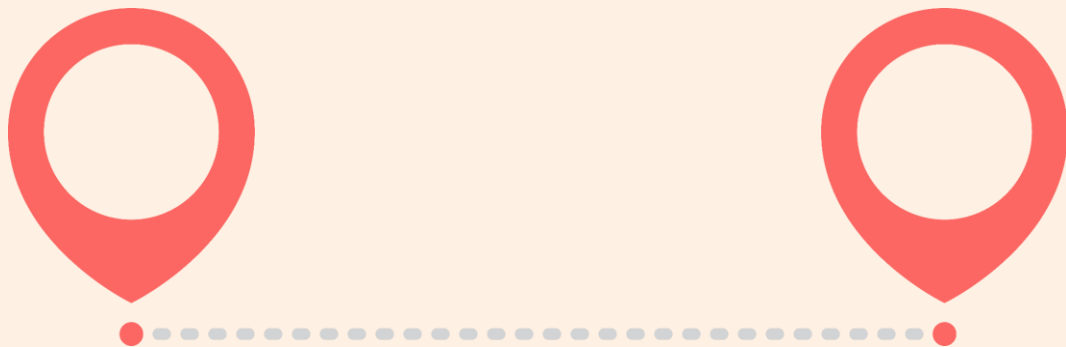

實驗結論 - 重量是影響平衡的因素之一



(天平左邊) (天平右邊)
重量X距離 = 重量X距離





嘎哧

狐狸急忙往回跑，這次原木向相反的方向傾斜起來。
狐狸每動一下，原木就像蹺蹺板一樣搖晃著。”





嘎 哧

“這可得當心，不能亂動。要是掉進河水裏，就沒救了。”

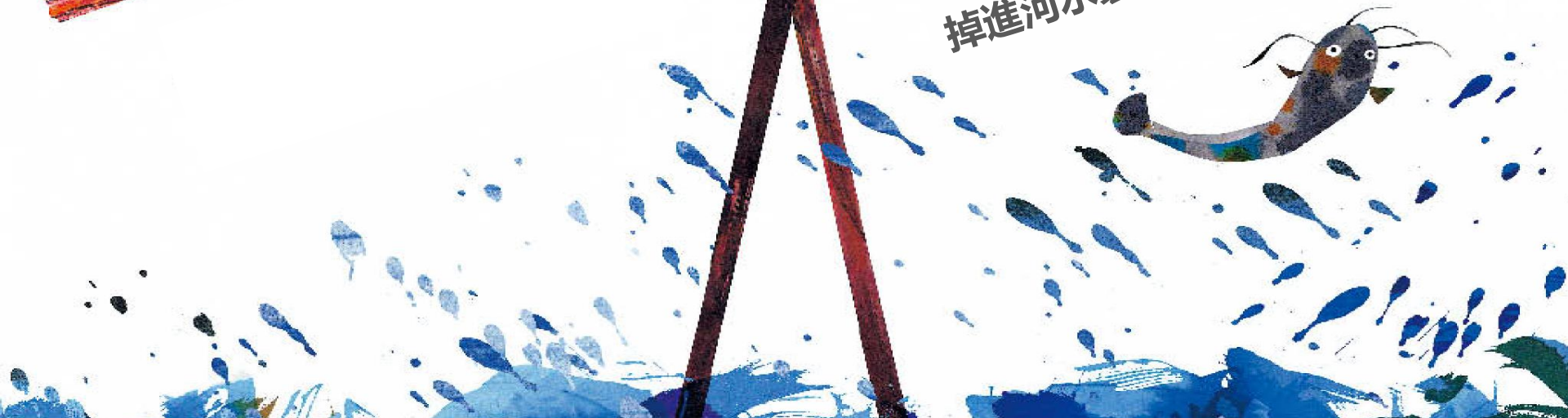



嘎 哧

狐狸找到了刚好能保持平衡的地方。



An illustration featuring a fox and a rabbit on a horizontal log. The fox is on the left, and the rabbit is on the right. A vertical stick is positioned in the center, with a horizontal stick crossing it, forming a tripod-like structure. The background is a warm, yellowish-orange gradient with a large sun or moon. The bottom of the image has a blue and white abstract pattern.

狐狸惱火地嘟囔著：

“咳，眼看著美食就在眼前，卻只能一動不動地呆在這兒。”

兔子也瞪著狐狸，說：

“哼！我不是也跑不了了嗎！不過，等我的夥伴趕來，會用棍子把你捅下河去的。”

An illustration featuring a fox and a rabbit on a dark, horizontal branch. The fox is on the left, and the rabbit is on the right. The background is a warm, yellow-orange sunset with a large sun. In the foreground, two wooden poles are tied together at the top with red string, forming a tripod shape. The bottom of the image has blue ink splatters.

狐狸當然也要反擊，他說：

“等我的夥伴趕來，就一個分一半，把你吃掉。”

“喂——來人啦！”

“快來人啦！”

他倆衝著黃昏的天空，拼驚全力喊起來。

不一會兒——

A large flock of black birds is gathered on a thick, dark brown wooden beam. The beam is supported by a wooden tripod stand. The background is a bright yellow-orange color. Some birds are perched on the beam, while others are in flight. The scene is dynamic and busy.

“在喊我們嗎？呱呱”

“喊我們有什麼事嗎？呱呱”

烏鴉們一個接一個地聚集過來，
準備落到原木上。

“喂，喂！不是在叫你們！”

“喂，喂！別都往這邊落呀！”

因為烏鴉們隨意地落下來，原木
開始忽忽悠悠晃動起來。

活動二——烏鴉來幫忙

實驗記錄表

活動2

狐狸

兔子

橋是平衡的嗎？



✓

×

活動二——烏鴉來幫忙

實驗記錄表

活動2

狐狸	兔子	橋是平衡的嗎？	
		✓	✗

活動二——烏鴉來幫忙

實驗記錄表

活動2

狐狸	兔子	橋是平衡的嗎？	
		✓	✗



✓

×



✓

×



✓

×

實驗結果 - 狐狸在哪裏能獲得平衡？



實驗結果 - 狐狸在哪裏能獲得平衡？

狐狸在每個格子都**不能**獲得平衡。



實驗步驟

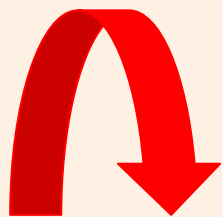

提出問題

1. 狐狸站在哪裏可以得到平衡
1. 狐狸和烏鴉站在哪裏可以得到平衡

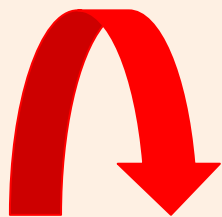

提出假設

實驗

- 實驗活動1
- 實驗活動2



得到結論

- 影響平衡的因素有：
1. 距離
 2. 重量

“哎呀，天要黑啦，呱——”

“好啦，快回去吧，呱！”

烏鴉們亂哄哄地飛向黃昏的天空，散去了。

兔子和狐狸瞪著烏鴉群，都舒了一口氣。

“呵，這幫隨隨便便的家夥！”

“嚇死我了！我真的以為原木要掉下去了。”



一個晚上過去，從天上吹下來的晨風變得越來越大了。

“呼——呼——”

原木被風吹動，開始慢慢地轉了起來。

“喂，兔子！別掉下去啊！”

“知道了，你也不能鬆手啊！”

他倆死死摟住原木。

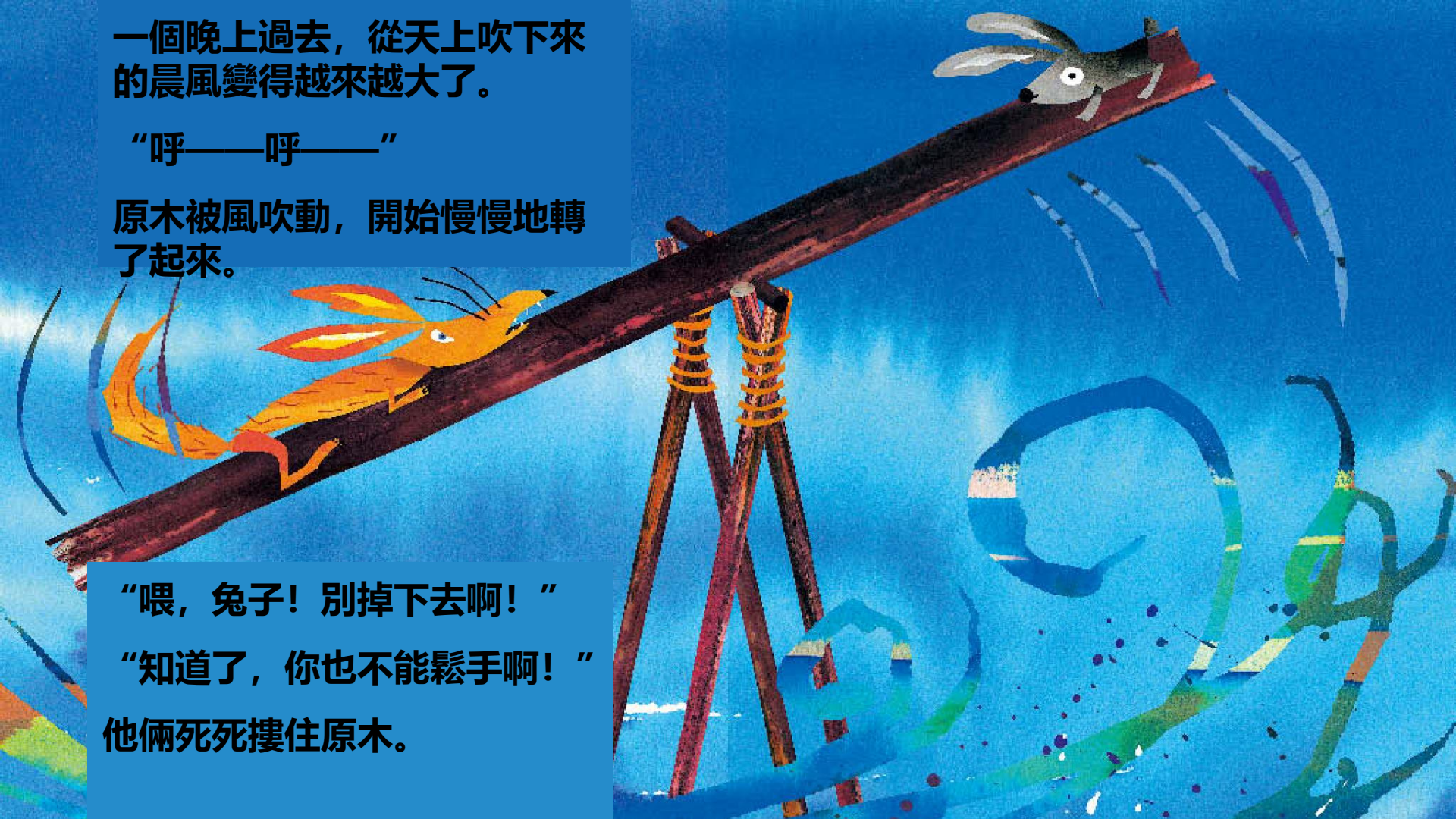

兔子和狐狸的身體被原木掄得轉起來，哧溜哧溜，滑到了原木頂端那裏……

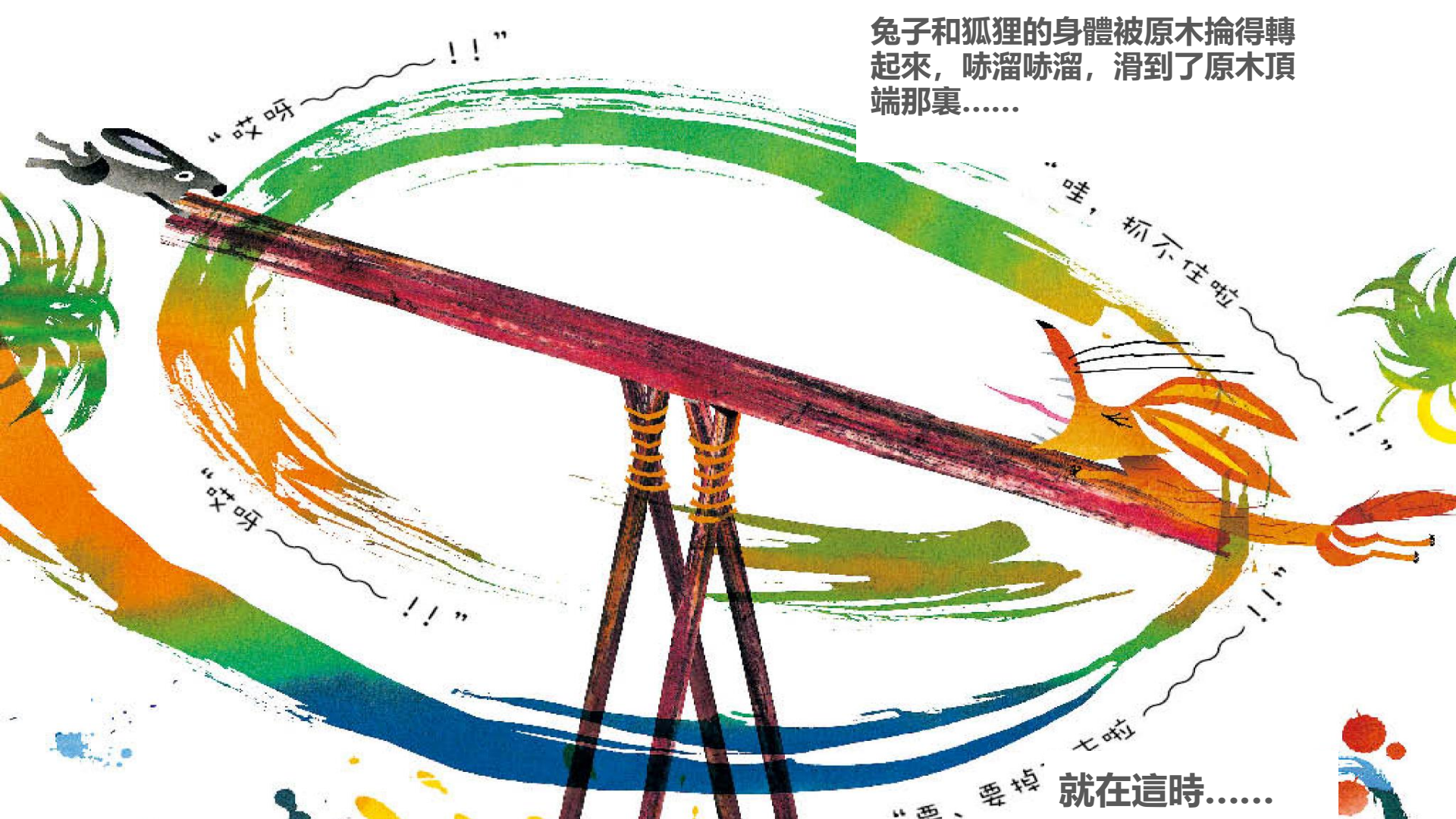

“哎呀——！！”

“哇，抓不住啦——！！”

“哎呀——！！”

“！！”

“要掉——七啦——！！”

就在這時……

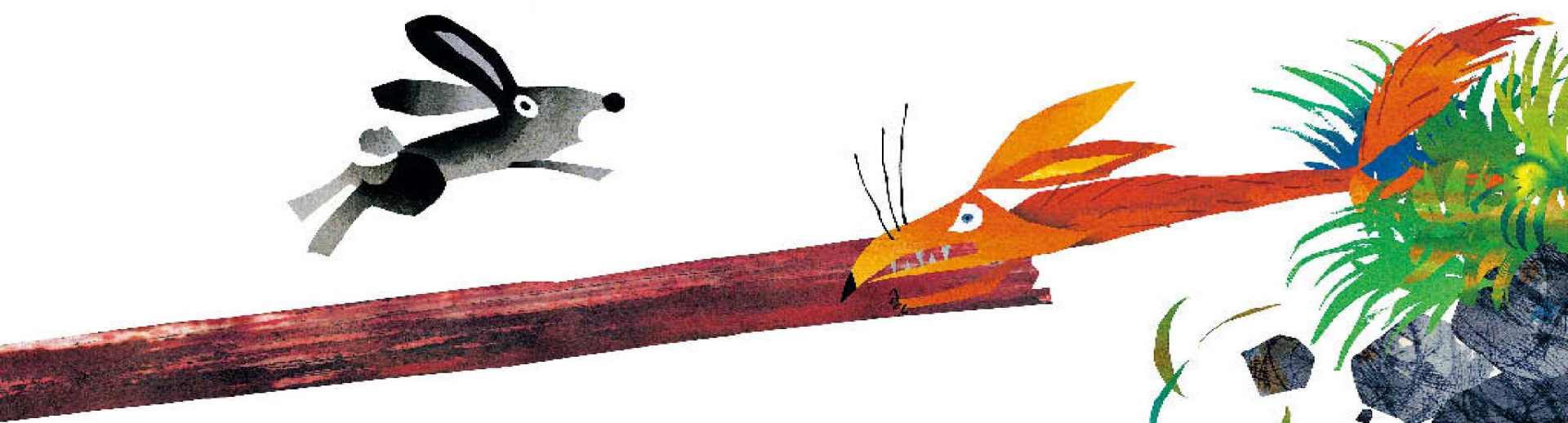

刷刷刷——

狐狸的脚被河堤上的草叢纏住了。

“快！兔子！快過去！”

“知道了！”

兔子踩著狐狸的背，跳了過去。

“來，抓住我！”

“好嘞，上來了。”

狐狸抓住兔子的手，也爬上了河堤。

就在那一瞬間——

撲通！



水花濺到了狐狸的腳下。

是原木掉到了河裏。

“嗷——得救了！”

“咳——嚇死我了！”

兔子和狐狸高興得一同歡呼起來。

可是……

呼起來。





狐狸猛然醒過神來，眼睛裏亮光一閃。

“哎呀，不好！”

兔子騰地一蹬腳，一溜烟地逃走了。

“站住！”

狐狸在後面追著兔子，可是，他突然又停了下來。



知識拓展

The background features a stylized forest scene. On the left and right sides, there are large trees with dark green foliage and brown trunks. In the center, there are lighter blue, semi-transparent trees. The sky is a light beige color with a few light blue clouds. At the bottom left and right corners, there are small red flowers with yellow centers and yellow leaves, set against dark green bushes.

跷跷板



秤



盤秤

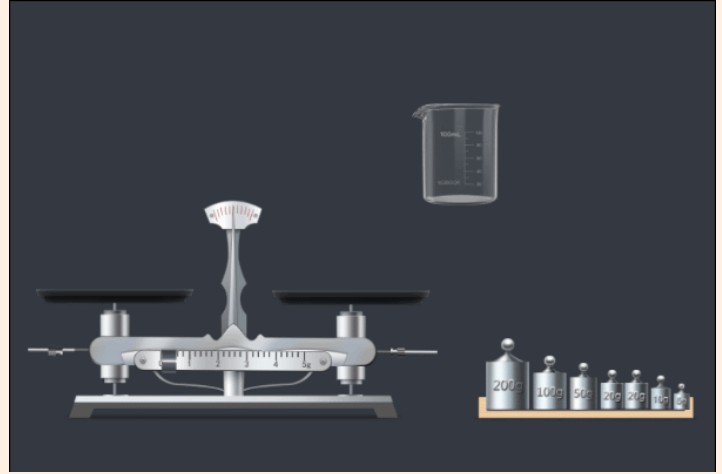

桿秤



動手做一做

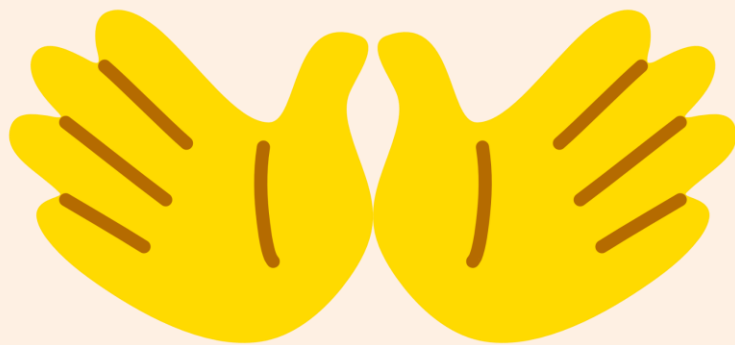

跷跷板





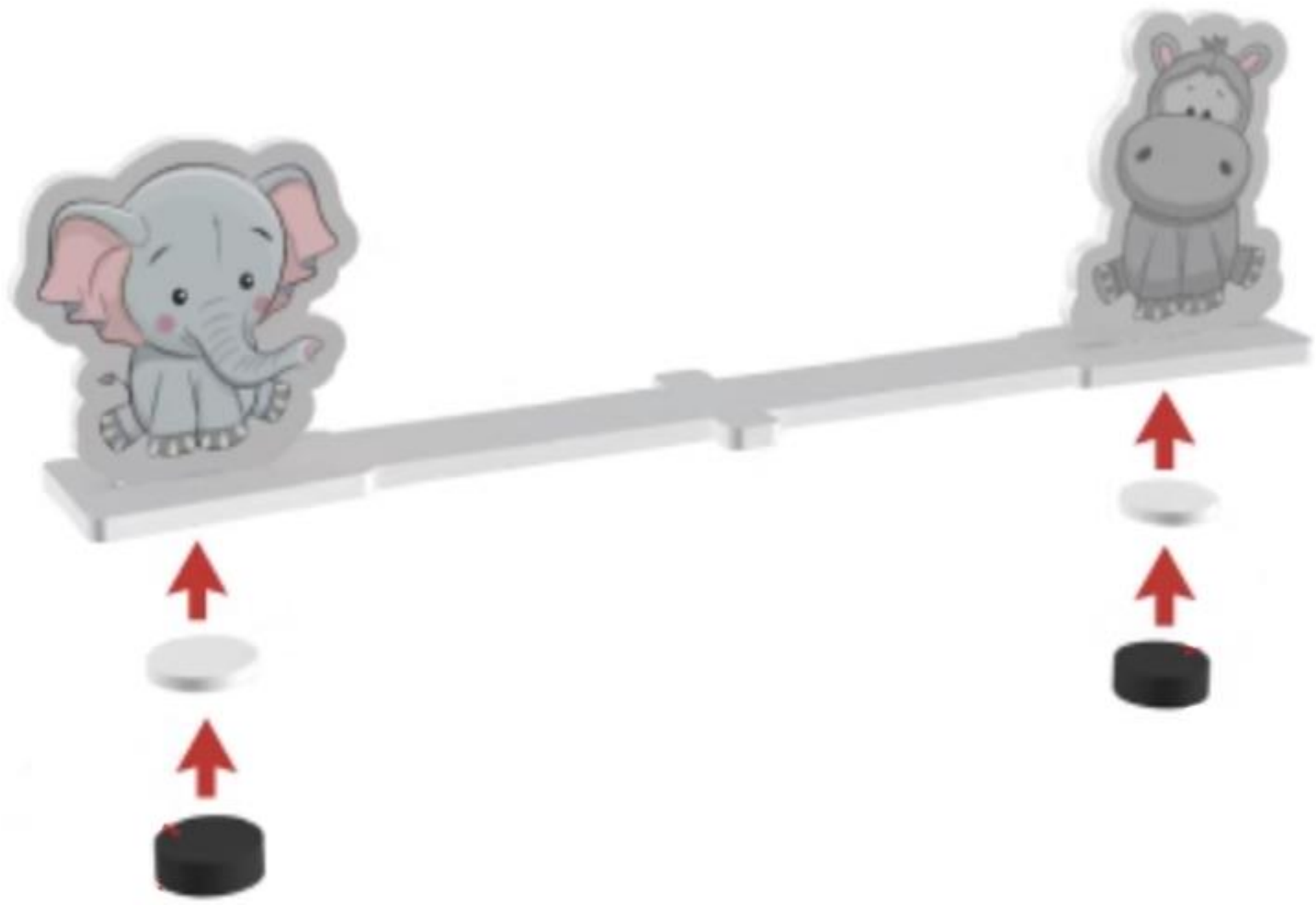

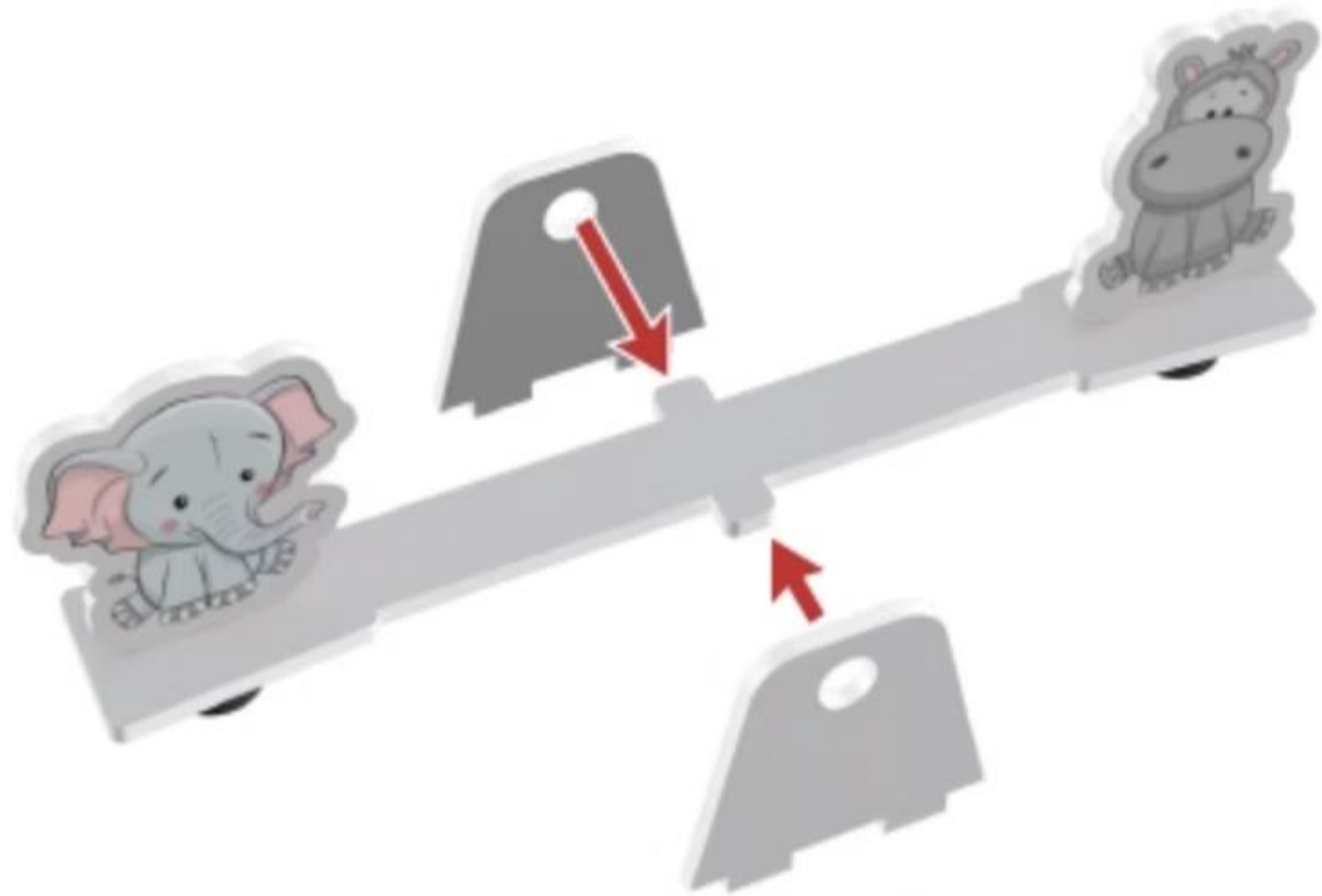

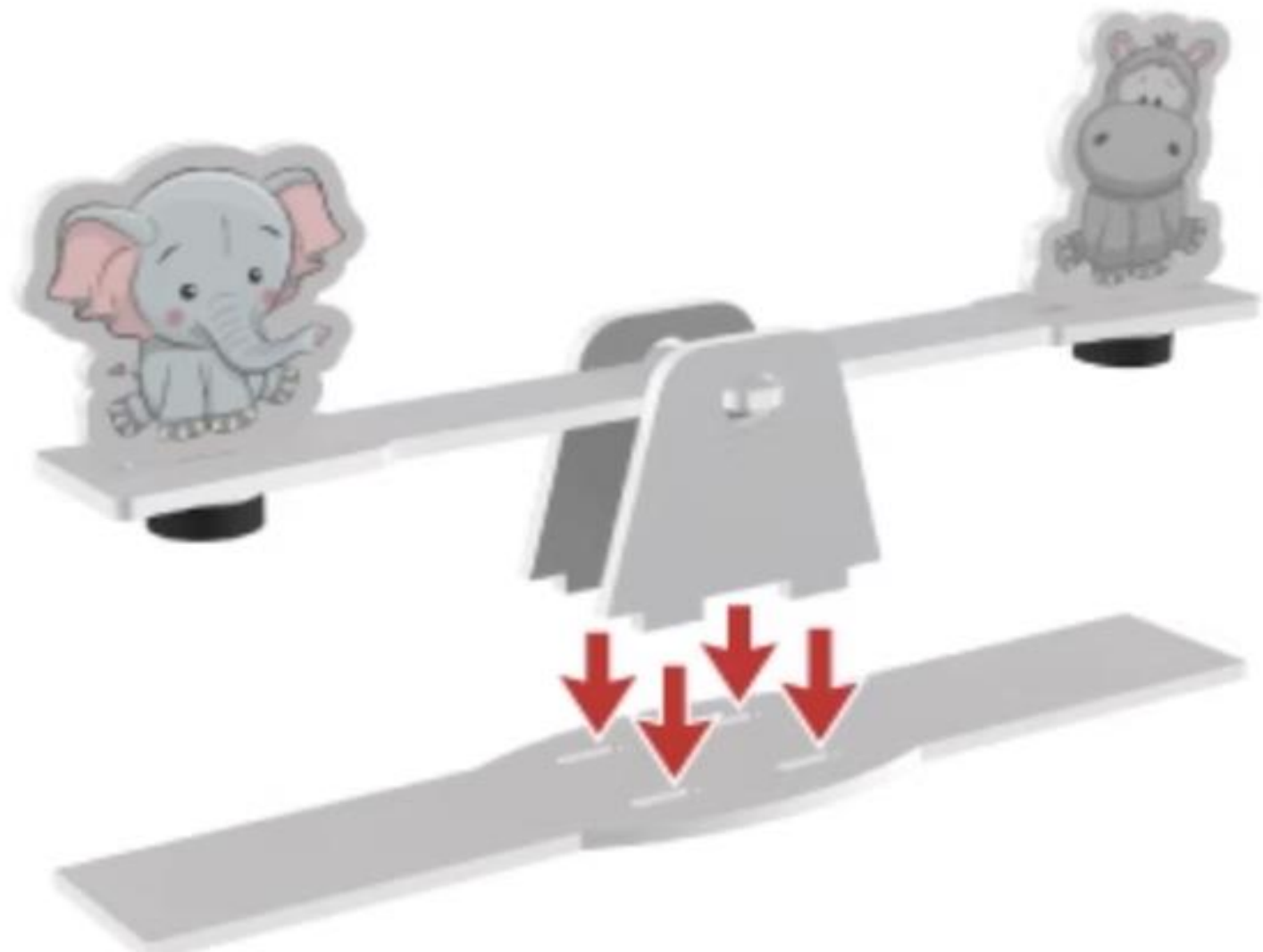

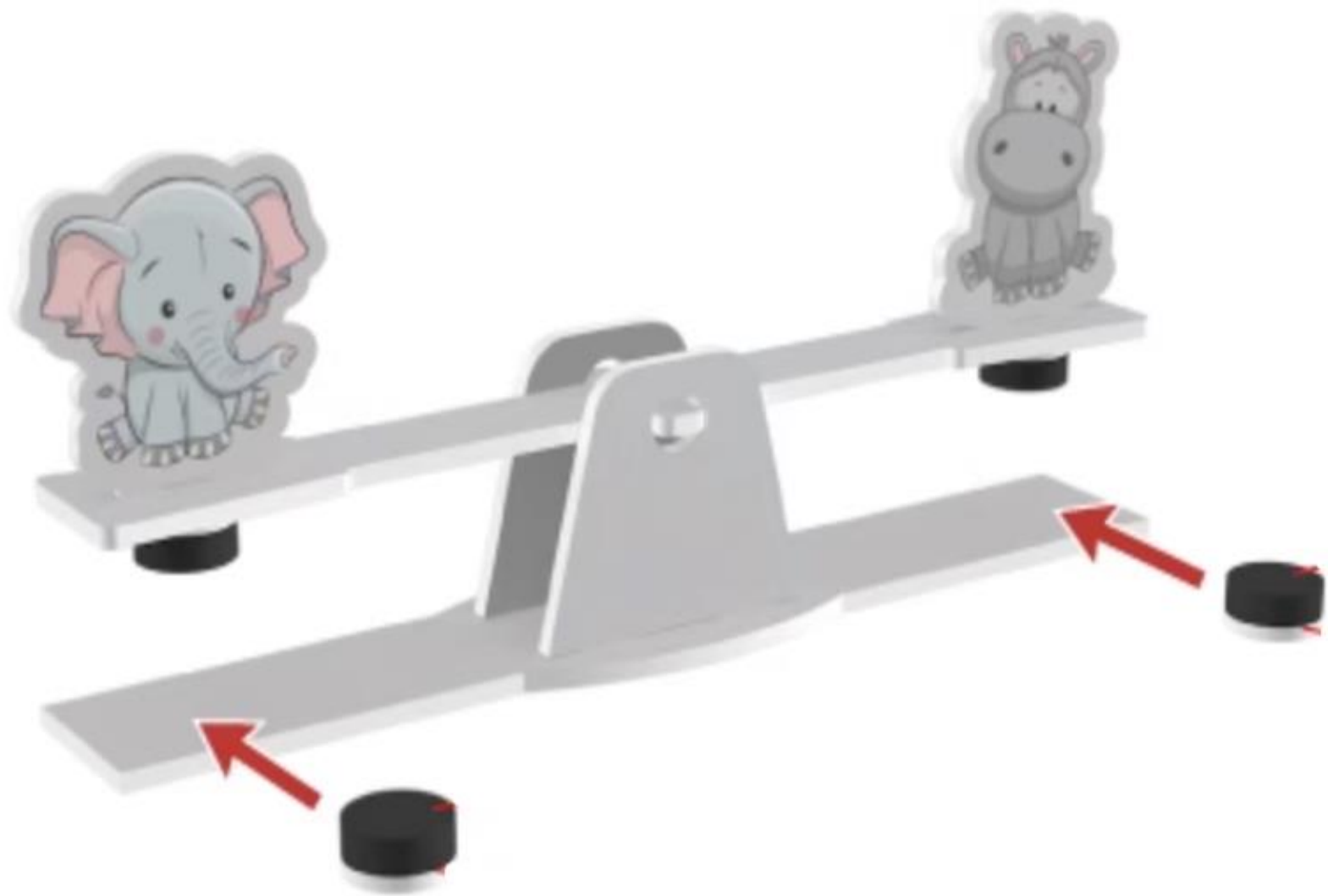

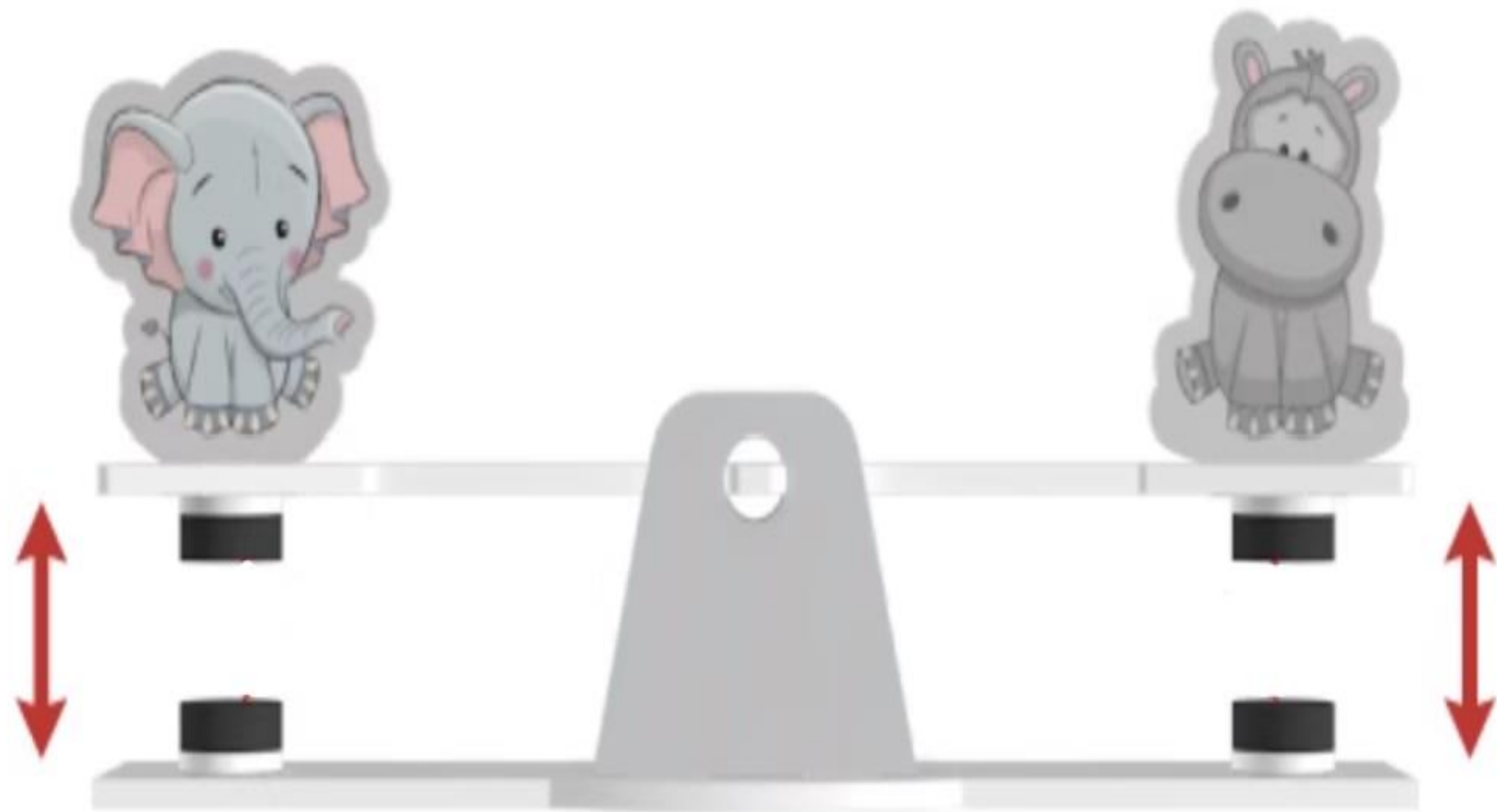

搖搖晃晃的橋

